

HV 三芯连接器组装说明

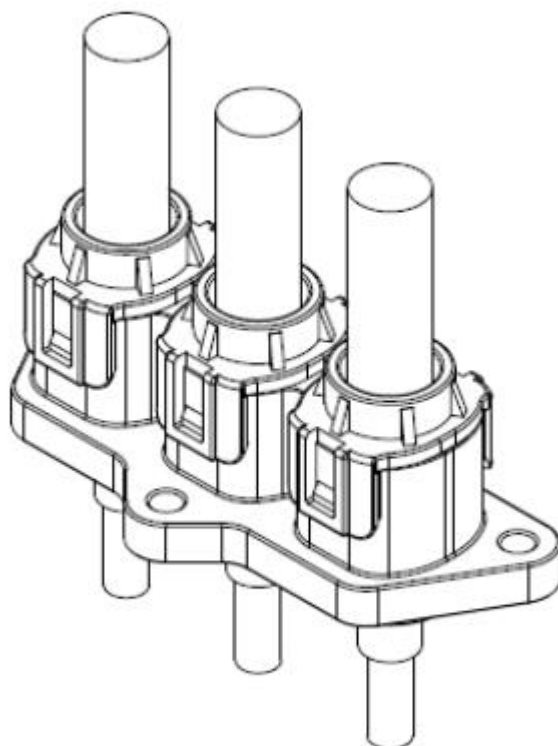

HVB331X-35

HVB331X-50

HVB331X-70

组装步骤 Assembly Instruction

步骤1：选取合适线缆，按照下表尺寸剥离绝缘皮和外皮，并将屏蔽线反折，修剪保留屏蔽14±1mm

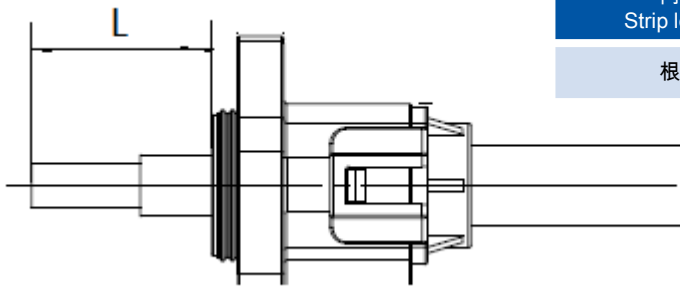
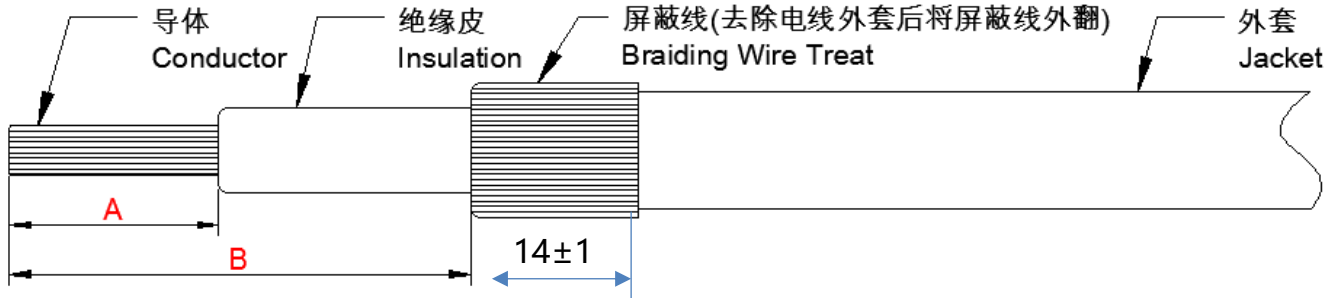

内皮剥线长度 Strip length "A" (mm)	外皮剥线长度 Jacket strip length "B"(mm)
根据客户端子	L+12mm

步骤2：将HV连接器所带的图示配件套入线材中



步骤3：将HV连接器所带的铜套套入线材屏蔽反折处，铜套边缘与外被口平齐，压紧，完成后外皮切口不能超出铜套边缘，拉力满足150N，注意压接位置，推荐压接高度参照下页

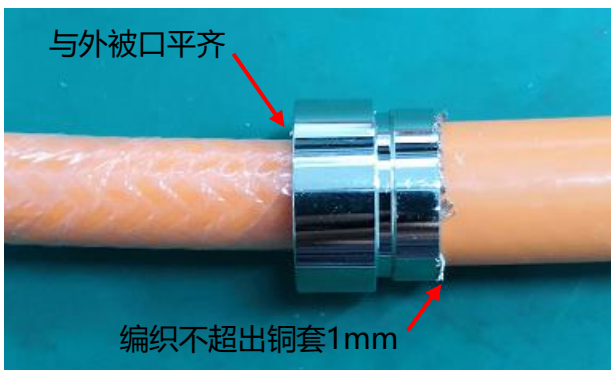

组装步骤 Assembly Instruction

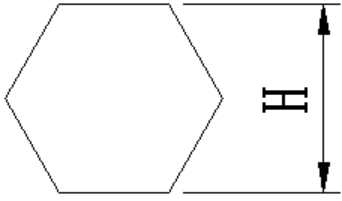

正六边压接

线材尺寸 Cable Size	H(mm)
35mm ²	15.5±0.5
50mm ²	18.0±0.5
70mm ²	19.8±0.5

步骤4：客户根据所选端子要求压接好端子，推荐芯线压缩比为80~90%，

步骤5：将HV连接器所带的接触环卡住铜套前端，取一根线穿入接头主体PIN C，轻压屏蔽环两翼，塞入HV金属壳中如图所示，

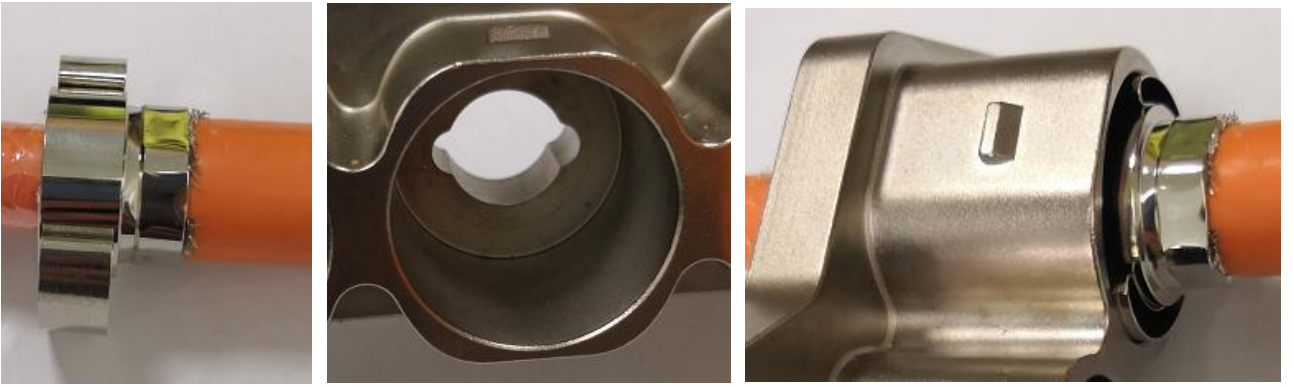

步骤6：将剩下的密封胶套、后密封圈与尾盖顺次压紧装入HV金属壳中



尾盖两侧卡扣需卡到位



组装步骤 Assembly Instruction

步骤7：重复以上步骤组装好 PIN B与PIN A 的线材。

步骤8：如图示在接头上套上三个前密封圈。

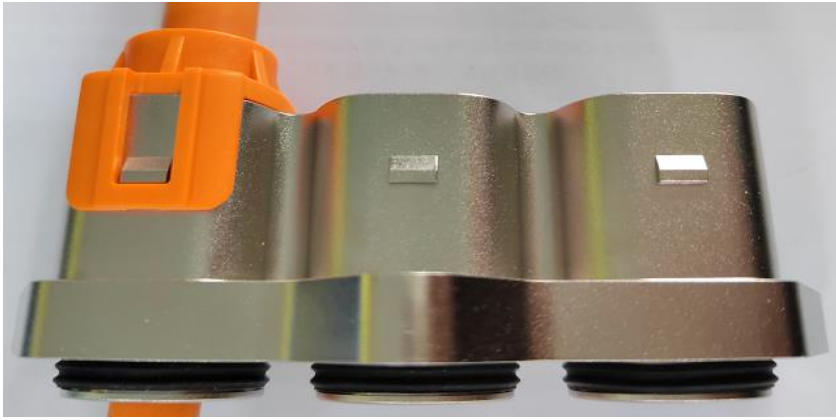

其它说明

法兰盘螺丝安装扭矩推荐：2.4~3.6N.m。

线缆尺寸与端子尺寸推荐参照下表。

推荐线缆尺寸

线缆导体截面积	绝缘层线径	外皮线径	推荐过孔端子宽度尺寸
35mm ²	10.0±0.4	14.1±0.4	≤16.5mm
50mm ²	12.5±0.4	17.1±0.5	≤18.5mm
70mm ²	14.5±0.4	19.1±0.5	≤18.5mm (AC-CP001460)



Amphenol Technical Products International provides the above product specifications for the standard HV Flange series of connectors to assist users in identifying the correct product for the system to which the connectors may be applied. Specifications are subject to change without notice. Contact your nearest Amphenol Corporation Sales Office for the latest specifications. All statements, information and data given herein are believed to be accurate and reliable but are presented without guarantee, warranty, or responsibility of any kind, expressed or implied. Statements of suggestions concerning possible use of our products are made without representation or warranty that any such use is free of patent infringement and are not recommendations to infringe any patent. Specifications are typical and may not apply to all connectors. Note that these specifications are derived from relevant global standards used in the automotive and industrial transportation markets, but they are not a substitute for system level design validation testing, which is the sole responsibility of the system designer and/or end user.

Asia Pacific

ChangZhou, China
Tel: +86 519-8981 9713
Add: No.11 Fengxiang Road, New District, Changzhou, Jiangsu
P.C: 213001

Asia Pacific

GuangZhou, China
Tel: +86 20-3210 6099
Add: 9th Floor, No. 10, the 4th Street, Kehui Jingu, Luogang District, Guangzhou ,Guangdong
P.C: 510663

North America

Winnipeg, Canada
Tel: +1 204 697 2222
Add: 2110 Notre Dame Avenue

Europe

Milano, Italy
Tel: +39 02 932541
Add: Via Barbaiana 5, 20020 Lainate(MI)

Email: info@Amphenol-GEC.com